

Digital duplicator

RISO SF **ETI** series

Speed Forward Edition II



An upgraded print system for use in various settings,
including schools and offices

Presenting the SF EII series, a new, truly global brand with solutions for every user need

RISO has been effectively fulfilling all users' needs in more than 190 countries and regions by constantly listening to feedback from our customers to continually enhance our products.

The SF EII series is a significant milestone as well as being a masterpiece of RISO's ceaseless innovation.

With its superior operability, high speed and outstanding print quality, the SF EII series advances you into a whole new dimension of printing.

SF 9000 EII models

600x600 dpi 150 ppm



SF 5000 EII models

300x600 dpi 150 ppm

300x600 dpi 130 ppm



Productivity

High-speed printing with excellent efficiency

High-speed 150 ppm* printing

Achieving 1000 pages printed in approx. 7 minutes, this surprisingly rapid rate will efficiently support your heavy paperwork requirements.

*Printing speed varies according to the model.



Overwhelmingly economical print costs

The SF EII series makes prints from a master. The more pages generated from each master the lower the cost per print. This means you can benefit from highly economical large-volume printing in the long run.



Print quantity and cost per print

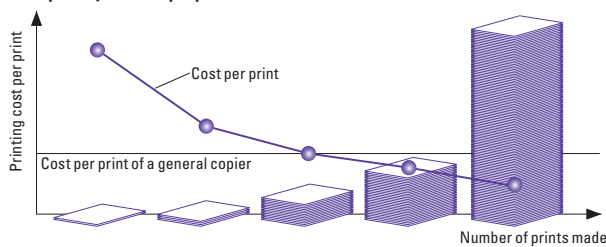

Multiple Page Printing

Page layout printing combines multiple copies of the same page, or copies of multiple pages onto a single printed page to save paper. Conveniently condense bulky multiple-page documents in an easy-to-read format. These functions are available when using the printer driver.

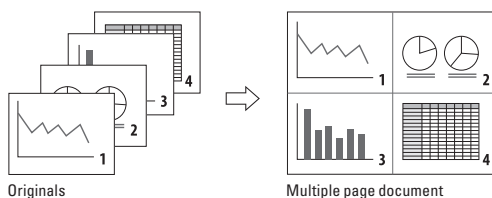

Heavy-load paper feeding

The paper feed tray has a capacity of 1000 sheets* for both feeding and receiving, which ensures uninterrupted printing over a longer period.

*When using the following weights of paper: 64 gsm to 80 gsm.



Easily adjustable receiving tray

The receiving tray can be adjusted easily with a click feeling for each standard paper size. Improved design allows printed papers to settle in an orderly way for smooth pickup.

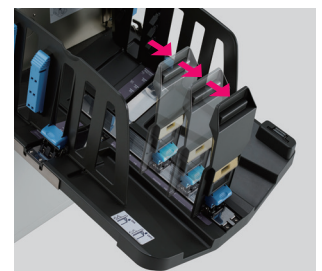

Improved printing experience with convenient operability and various new functions

Color control panel (For SF9000 EII models)

The easy-to-use control panel provides intuitive operation. Functions for printing, copying, scanning and managing data are all at your fingertips, logically arranged for intuitive operation on a 7-inch color LCD touch screen.

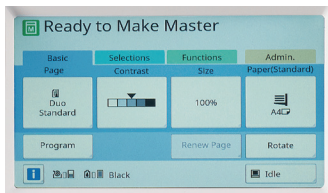

Paper Memory Print **NEW**

Paper Memory Print is useful when it is difficult to print directly from a PC or use a USB memory. Also, converting original data into a digital pattern improves confidentiality and helps prevent information leaks.

This function easily converts original data created on a PC into a "Paper Memory Data" digital pattern. Scanning the data, the SF EII series retrieves the original data by decoding the digital pattern, achieving the same high quality of output image as that being processed through the PC.

• A laser printer with 600 dpi or higher resolution is required to achieve this function.

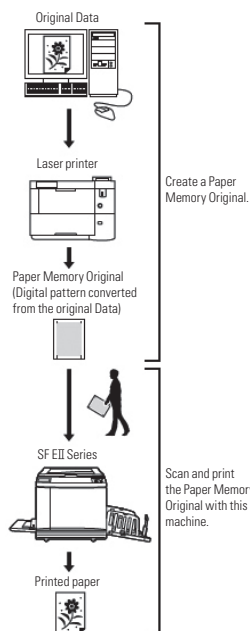

Overlapped feeding detection **NEW**

If paper is fed overlapped, it is automatically detected and the user is informed.

Easy guidance for changing consumables **NEW**

Reading the QR code attached on the duplicator body with a smart device leads to an instruction video on RISO's YouTube channel showing how to replace the master roll and ink cartridge, and empty the master disposal box.



Versatile program print

For example, you can print question papers for three different classes, A, B and C, that contain different numbers of students (see Program A below). Simply set up the program, place the three original tests in the Auto Document Feeder and press "print" — you'll automatically receive the required numbers of each individual test (see Program B below).

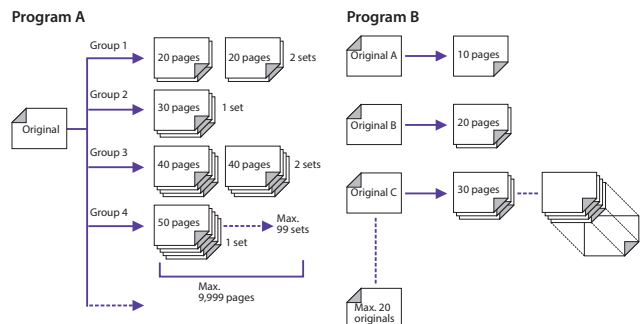

Paper insertion function for easier sorting **NEW**

The SF EII series can be programmed to insert a white sheet each time a designated number of pages has been printed. This makes it easier to sort and confirm the amount of documents completed.



Automatic standard envelope size detection **NEW** (For SF9000 EII models)

The paper feed tray automatically detects standard envelope sizes, so customized registration is not required.

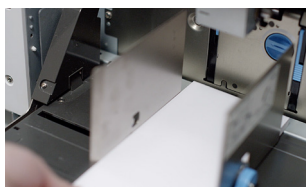

Text-to-speech reading function of the User's Guide in English **NEW**

The PDF User's Guide can be read out in English, helping to guide operation for anyone with vision difficulties.

Various printing approaches

The SF EII series offers various ways of printing, depending on your specific requirements.

- Standard equipment of PC-I/F
- Direct printing from a USB flash drive
- General SD card compatible for data storage (For SF9000 EII models)



IC card security

Enhanced security via the optional IC card activation kit. (Separate IC card reader required). Only an authorized user can perform printing, effective to prevent divulging information from confidential documents.



Usage report

The SF EII series provides RISO Copy Count Viewer for counting users' printouts, useful for understanding expenses and usage restriction. The aggregate results are available via printout or USB flash drive.

ID	User Name	Group No.	Device Name	Model Name	Model Code	Copy Count	Print Count	Scan Count	Facsimile Count	Other Count	Total Count
1	ADMIN	1	PRN001	PRN001	PRN001	1000	0	0	0	0	1000
2	ADMIN	1	PRN002	PRN002	PRN002	500	0	0	0	0	500
3	ADMIN	1	PRN003	PRN003	PRN003	200	0	0	0	0	200
4	ADMIN	1	PRN004	PRN004	PRN004	100	0	0	0	0	100
5	ADMIN	1	PRN005	PRN005	PRN005	50	0	0	0	0	50
6	ADMIN	1	PRN006	PRN006	PRN006	25	0	0	0	0	25
7	ADMIN	1	PRN007	PRN007	PRN007	12.5	0	0	0	0	12.5
8	ADMIN	1	PRN008	PRN008	PRN008	6.25	0	0	0	0	6.25
9	ADMIN	1	PRN009	PRN009	PRN009	3.125	0	0	0	0	3.125
10	ADMIN	1	PRN010	PRN010	PRN010	1.5625	0	0	0	0	1.5625
11	ADMIN	1	PRN011	PRN011	PRN011	0.78125	0	0	0	0	0.78125
12	ADMIN	1	PRN012	PRN012	PRN012	0.390625	0	0	0	0	0.390625
13	ADMIN	1	PRN013	PRN013	PRN013	0.1953125	0	0	0	0	0.1953125
14	ADMIN	1	PRN014	PRN014	PRN014	0.09765625	0	0	0	0	0.09765625
15	ADMIN	1	PRN015	PRN015	PRN015	0.048828125	0	0	0	0	0.048828125
16	ADMIN	1	PRN016	PRN016	PRN016	0.0244140625	0	0	0	0	0.0244140625
17	ADMIN	1	PRN017	PRN017	PRN017	0.01220703125	0	0	0	0	0.01220703125
18	ADMIN	1	PRN018	PRN018	PRN018	0.006103515625	0	0	0	0	0.006103515625
19	ADMIN	1	PRN019	PRN019	PRN019	0.0030517578125	0	0	0	0	0.0030517578125
20	ADMIN	1	PRN020	PRN020	PRN020	0.00152587890625	0	0	0	0	0.00152587890625
21	ADMIN	1	PRN021	PRN021	PRN021	0.000762939453125	0	0	0	0	0.000762939453125
22	ADMIN	1	PRN022	PRN022	PRN022	0.0003814697265625	0	0	0	0	0.0003814697265625
23	ADMIN	1	PRN023	PRN023	PRN023	0.00019073486328125	0	0	0	0	0.00019073486328125
24	ADMIN	1	PRN024	PRN024	PRN024	0.000095367431640625	0	0	0	0	0.000095367431640625
25	ADMIN	1	PRN025	PRN025	PRN025	0.0000476837158203125	0	0	0	0	0.0000476837158203125

RISO console

The total management system improves convenience by integrating applications in one place. Product, consumables and system information can all be checked easily on your PC.

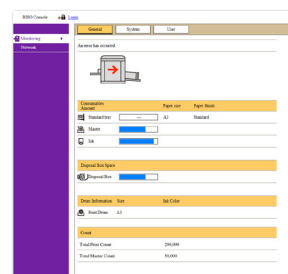

Quality

Outstanding image quality with 600 dpi, providing clear text and images with smooth gradations.

Image data processing raises the bar for 600x600 dpi scanning and printing

This achieves sharp and clear output with high image quality.

*For SF9000 EII models

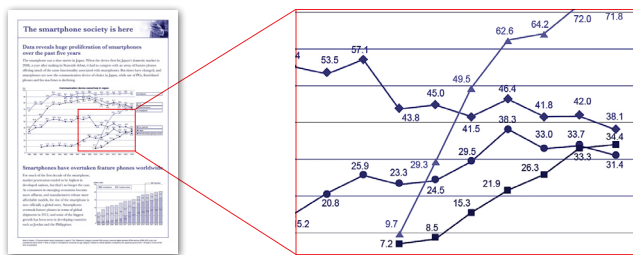

Thin lines, text and graphs are clearly scanned and reproduced in detailed printing.

Ink color variations

21 standard colors, 50 custom colors and special order-made colors are available. A wide range of printing colors can meet the needs of a variety of print jobs.

Red	Bright Red	RISO-Marine Red	Burgundy	Brown	Yellow	Green
Teal	Blue	Medium Blue	RISO-Fed. Blue	Purple	Flat Gold	Orange
Crimson	Hunter Green	Gray	Light Gray	Fluorescent Pink	Fluorescent Orange	Gold

[Custom colors]



Other functions for optimum output

- Auto base control
- Tone smooth function
- Four image-processing modes: Line, Photo, Duo, and Pencil



Enhanced features for clearer output

High scanning quality

The scanner attains smooth tonal gradation even with photo images.

- Reduced blown-out highlights via equalized dot description

Image-processing function

Decreases image deterioration through improved image processing, delivering clearer output.

- Minimizes blocked-up shadows through enhanced gamma correction
- Sharp outlines with contour enhancement achieved

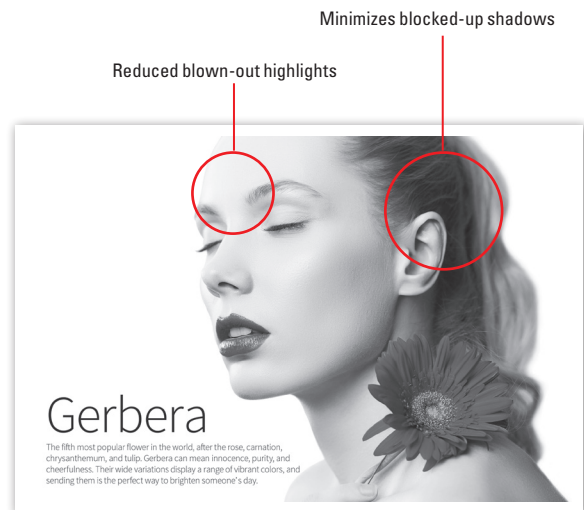

Sustainability

Energy saving and environmental considerations



Rice bran oil ink **NEW**

The rice bran oil ink contributes to environmental sustainability.

The biomass ratio of ink materials has been increased, which reduces the burden on the environment. Rice bran, which would be otherwise wasted, is a raw material with no VOCs, so after the oil is extracted for the ink it can subsequently be used as fertilizer or animal feed.



RISO FII type inks are certified with environmental certification marks issued by ink industry groups in Japan.

[Manufacturing Process]

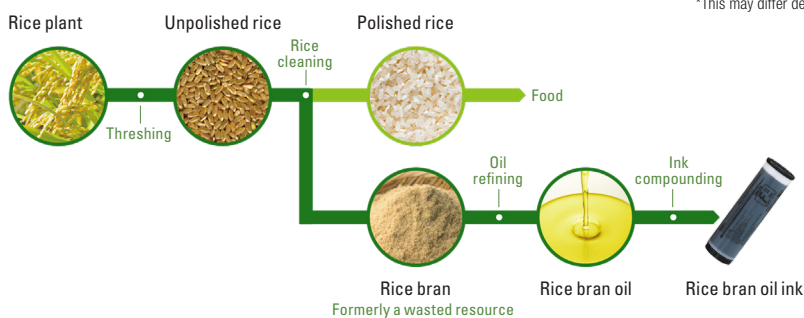

Energy saving

RISO Digital Duplicators do not use toners so a heater that is usually required for bonding toner to the paper is not necessary.

They employ automatic shut-off and sleep functions after a certain time interval elapses, to effectively reduce power consumption.

Ink-saving mode

While maintaining the printing quality, the amount of ink used can be reduced to 20%*.

*This may differ depending on printing mode, documents and other conditions.

Dimensions (SF EII series)

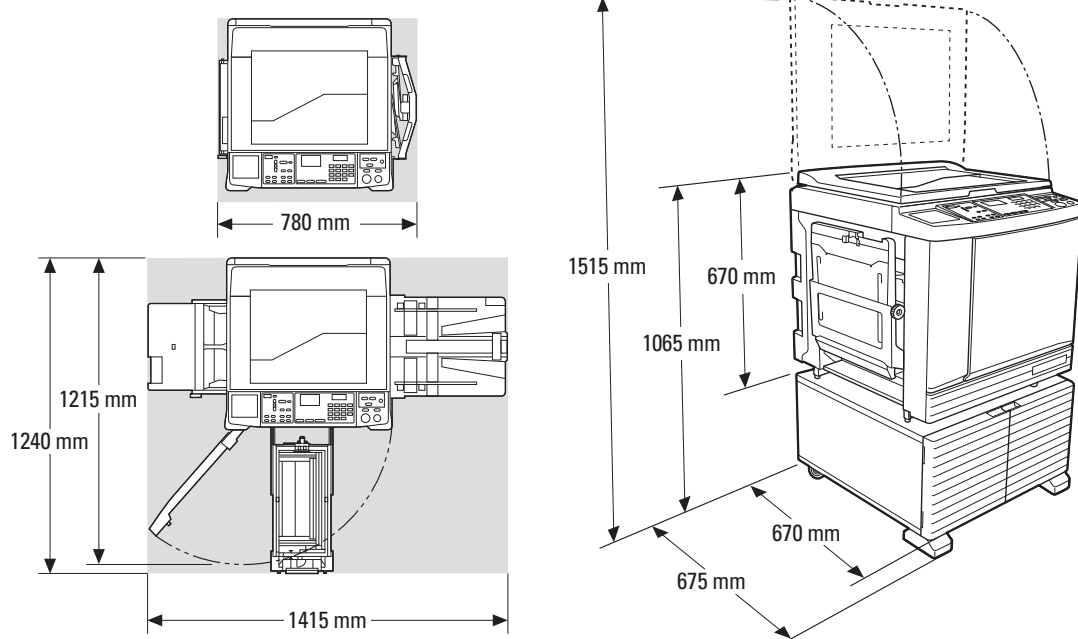

Optional Accessories

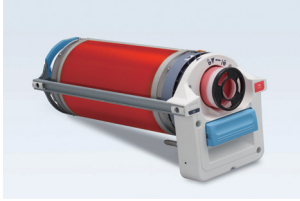

RISO FII Type Drum
Enables color printing
(Case included)

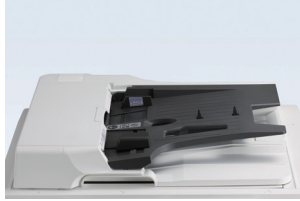

RISO Auto Document Feeder VII
Scans multiple documents automatically.



RISO Job Separator IV; NIII
Enables easy separation of printed sheets by inserting tape strips.



Wide Stacking Tray
Allows use of paper up to 555 mm on the long edge.
*Not available for some models.

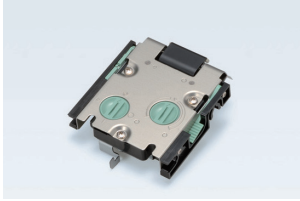

Card Feed Kit
Compatible with paper weight 100 gsm to 400 gsm.
*Please contact a RISO sales representative for the kinds of paper that may be used.



RISO Stand D Type III
Deluxe and with doors for convenient storage with a neat appearance.



RISO Stand N Type III
Sturdy open-front stand also offers convenient storage of consumables.

- IC Card Reader Activation Kit RG
- RISO Printer Driver for Macintosh
- RISO Network Kit S10
- *Equipped in some models.
- Envelope Feed Kit
- Compatible with paper weight 50 gsm to 120 gsm.

Consumables



RISO INK FII Type Black (1000 ml)



RISO INK FII Type Color (1000 ml)

RISO iQualitySystem™



The RISO i Quality mark indicates a RISO product compatible with the RISO i Quality System.



RISO MASTER FII Type A3
(220 sheets per roll)



RISO MASTER FII Type B4
(250 sheets per roll)



RISO MASTER FII Type Legal/A4
(Legal: 250 sheets per roll)
(A4: 295 sheets per roll)

and RISO, RISO i Quality System and RISO i Quality mark are trademarks or registered trademarks of RISO KAGAKU CORPORATION in the United States and other countries. Other corporate names and/or trademarks are either registered trademarks or trademarks of each company, respectively.
Copyright ©2019 RISO KAGAKU CORPORATION. All rights reserved.

For more details please contact:



RISO KAGAKU CORPORATION
5-34-7 Shiba, Minato-ku, Tokyo 108-8385 Japan
<https://www.riso.com/>