



The world's fastest digital duplicator, pushing standards to the next level.

Digital duplicator

RISO

190 ppm

SF9390

A3/190 ppm/600 x 600 dpi/Full-color LCD touch panel/
Versatile connectivity

Introducing the SF9390, the all-new global brand of digital duplicators that meets all kinds of user needs

With our products employed in over 180 countries and regions, RISO has been successfully meeting all user requirements by constantly listening to feedback from our customers in order to continually improve our quality. The SF9390 is an important milestone and a masterpiece of our ceaseless innovation. With the fastest speed plus superior operability and print quality, this advanced model ushers you into a higher dimension of printing.





SUPERB PRODUCTIVITY:
190 ppm ultra high-speed printing



EASY OPERATION:
Refined, full-color control panel design

HIGH DEFINITION:
600 x 600 dpi high-resolution with improved image quality



RISO **SF9390**

“Since print volume is normally very large, time and costs are major concerns...”

RISO offers outstanding productivity through high speed and low cost even for a wide variety of short-run prints.



World's fastest, ultra-high-speed printing at 190 ppm **Improved**

Achieving 1000 pages printed in approx. 5 minutes, this is the world's fastest printing speed. This surprisingly rapid rate will efficiently support your heavy paperwork requirements.



Quick Master Making mode **NEW**

A new function, Quick Master Making mode, shortens the master-making time while still maintaining high image quality.

Heavy-load paper feeding

The paper trays have a capacity of 1000 sheets* for both feeding and receiving, which ensures uninterrupted printing over a longer period.

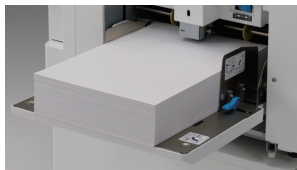

*When using the following weight of paper; 64 gsm to 80 gsm

Overwhelmingly economical print costs

The SF series makes prints from a master. As a result, the more pages generated from each master the lower the cost per print, making it highly economical for medium- to high-volume printing.

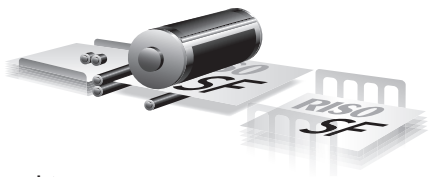

Print quantity and cost per print

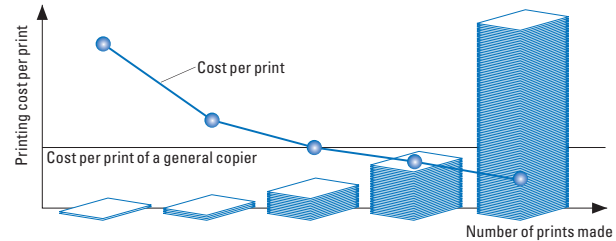

Paper saving

Page layout printing combines multiple copies of the same documents, or copies of multiple documents onto a single printed page to save paper. Conveniently condense bulky multiple-page documents in an easy-to-read format. These functions are available when using the printer driver.

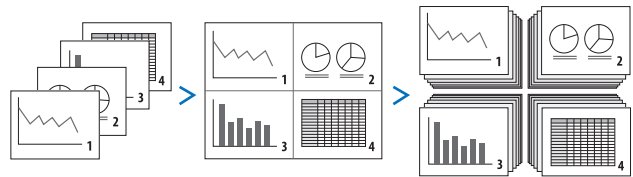

Versatile paper printing capability

The SF series accepts a wide range of paper types such as recycled paper, coarse paper, cards and envelopes, giving you the perfect options for any job. These multiple roles expand the scope of your business without installing specialized equipment.

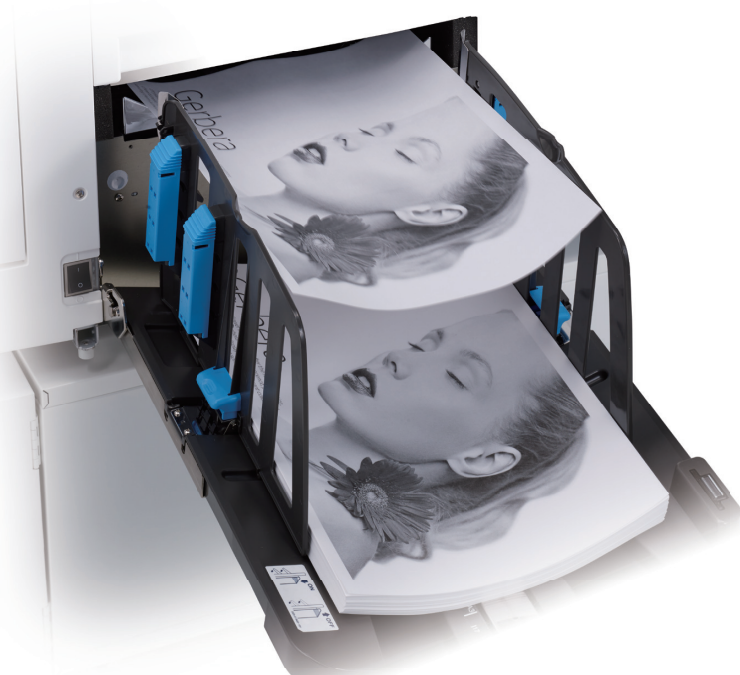

“I wonder if we need a professional operator for such digital duplicators...”

RISO offers simple operations through easy-to-master panel and interface design for everyone.



Redesigned, full-color control panel **Improved**

New, easy-to-use control panel provides intuitive operation. Functions for printing, copying, scanning and managing data are all at your fingertips, logically arranged for intuitive operation on a large 7-inch color LCD touch screen.

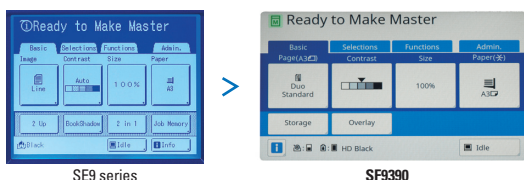

Various printing approaches

The SF series offers various ways of printing, depending on your specific requirements.

- Standard equipment of PC-I/F
- Direct printing from a USB flash drive
- General SD card compatible for data storage



Paper insertion function for easier sorting **NEW**

The duplicator can be programmed to insert a white sheet each time a designated number of pages has been printed. This makes it easier to sort and confirm the amount of documents completed.

Paper Memory Print **NEW**

Step 1

Using the printer driver function installed on your PC, original data created on the PC can easily be converted into a digital pattern, which can be printed on a sheet of paper with a laser printer.*

Step 2

You can then scan the digital pattern created as in Step 1 through SF9390, and easily retrieve the original data by decoding the digital pattern, achieving the same high quality of output image as that being processed through the PC.

* A laser printer with 600 dpi or higher resolution is required to achieve this function.

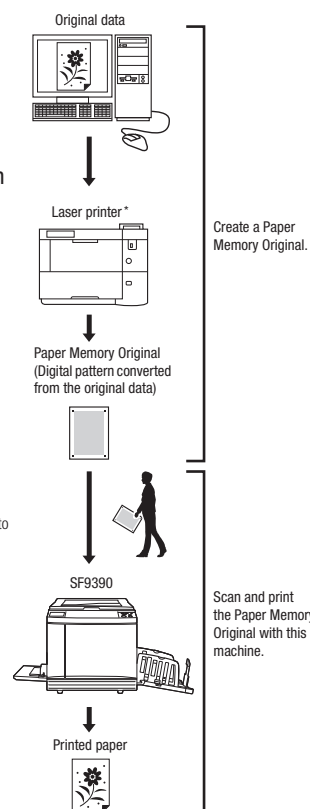

“For better visibility, we don’t want to compromise the beauty of the finish...”

RISO offers outstanding image quality, providing clear text and better images with smooth gradations.



Image data processing raises the bar for 600x600 dpi scanning and printing

This achieves sharp and clear output with the highest image quality.

Enhanced features for clearer output

High scanning quality **NEW**

The newly designed scanner attains smooth tonal gradation even with photo images.

- Reduced blown-out highlights via equalized dot description

Improved image-processing function **Improved**

Decreases image deterioration through improved image processing, delivering clearer output.

- Minimizes blocked-up shadows through enhanced gamma correction
- Sharp outlines with contour enhancement achieved

Ink color variations

21 standard colors, 50 custom colors and special order-made colors are available. A wide range of printing colors can meet the needs of a variety of print jobs.

Red	Bright Red	RISO-Marine Red	Burgundy	Brown	Yellow	Green
Teal	Blue	Medium Blue	RISO-Fed. Blue	Purple	Flat Gold	Orange
Crimson	Hunter Green	Gray	Light Gray	Fluorescent Pink	Fluores. Orange	Gold

[Custom colors]



Other various functions for optimum output

- Auto base control
- Tone smooth function
- Four image-processing modes: Line, Photo, Duo, and Pencil

Upgraded high-definition master: RISO MASTER F TYPE HG

More precise master copies can be made for reproducing subtle color gradations, clear photo images and even text written in pencil.

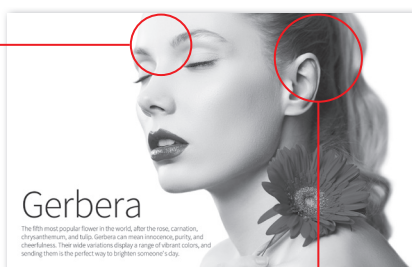

Gerbera

The 8th most popular flower in the world, after the rose, carnation, daffodil, geranium, and tulip, Gerbera can mean innocence, purity, and cheerfulness. Their wide variations display a range of vibrant colors, and sending them is the perfect way to brighten someone's day.

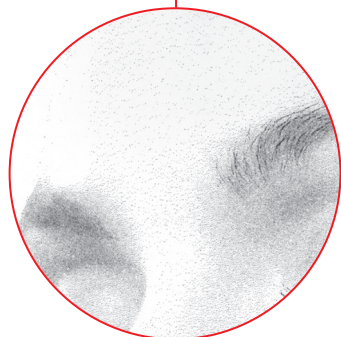

Smother tonal gradations



Precise reproduction



“How can we manage the information and consumables.”

RISO supports information and consumables management.



RISO console

The total management system improves convenience by integrating applications in one place. Product, consumables and system information can all be checked easily on your PC.

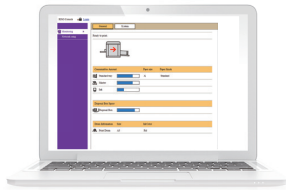

Usage report

The SF series provides RISO Copy Count Viewer for counting users' printouts, useful for understanding expenses and usage restriction. The aggregate results are available via printout, USB flash drive or email.

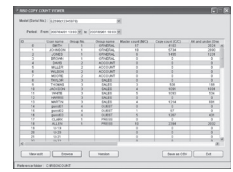

IC card security **NEW**

Enhanced security by an optional IC card activation kit. (Separate IC card reader required). Only an authorized user can perform printing, effective to prevent divulging information from confidential documents.



Text-to-speech reading function of the English instruction manual **NEW**

Parts of the instruction manual can be rendered audibly in English, helping to guide operation for anyone with vision difficulties.

“The environment is highly considered...”

RISO strongly cares about global environmental issues as well.

Energy Saving

Energy system with low power consumption. The SF series consumes 1/10th the energy, compared with ENERGY STAR® guidelines.

- * ENERGY STAR qualified and RoHS certified
- * Complies with the ErP directive in Europe



Rice bran oil ink **NEW**

The rice bran oil ink contributes to environment sustainability. Rice bran, which would be otherwise wasted, is a raw material with no VOCs, so after the oil is extracted for the ink. It can subsequently be used as fertilizer or animal feed.

Dimensions

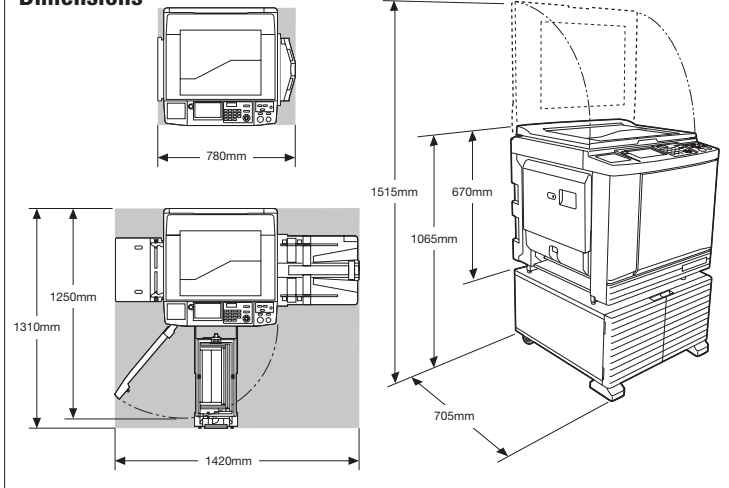

Optional Accessories

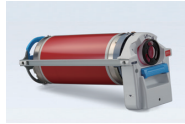

RISO MF/SF Drum

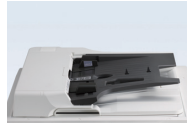

RISO Auto Document Feeder VII



Job Separator IV; NIII



RISO Controller IS300

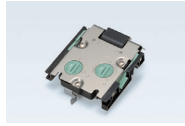

Card Feed Kit

Compatible with paper weight 100gsm-400gsm.
*Please contact a RISO sales executive for the kinds of paper that may be used.

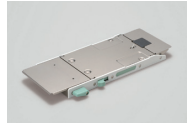

Envelope Feeder

Compatible with paper weights 50 gsm to 120 gsm.
*Please contact a RISO sales executive for the kinds of paper that may be used.



RISO Stand D Type III

Deluxe and with doors for convenient storage with a neat appearance.



RISO Stand N Type III

Sturdy open-front stand also offers convenient storage of consumables.

- IC Card Reader Activation Kit RG
- Wide Stacking Tray (Allows use of paper up to 555 mm in long edge.)
- RISO AUTO-CONTROL STACKING TRAY II
- RISO Printer driver for Macintosh

Specifications

Master Making/Printing Methods		High-speed digital master-making/Fully automatic printing
Original Type		Book or sheet
Master Making Time^{*1}	Quick Master Making mode	Approx. 14 seconds (A4, long edge feed) Approx. 18 seconds (A4, short edge feed)
	Normal master making mode	Approx. 16 seconds (A4, long edge feed) Approx. 20 seconds (A4, short edge feed)
Resolution	Scanning	600 dpi × 600 dpi
	Printing	600 dpi × 600 dpi, Quick Master Making Mode: 600 dpi × 400 dpi
Maximum Scanning Area		297 mm × 432 mm
Print Paper Weight		46 gsm to 210 gsm
Print Paper Size^{*2}		100 mm × 148 mm to 320 mm × 432 mm
Maximum Printing Area		291 mm × 413 mm
Paper Feed Tray Stacking Capacity		1000 sheets ^{*3} (stacking height of 110 mm or less)
Paper Receiving Tray Stacking Capacity		1000 sheets ^{*3} (stacking height of 110 mm or less)
Print Speed^{*4}		7 levels: 60, 80, 100, 120, 130, 160 and 190 sheets per minute
Print Position Adjustment		Horizontal: ±15 mm Vertical: ±10 mm
Image Processing Mode		Line, Photo (Standard/Portrait), Duo (Standard/Line/Photo/Shadow off), Pencil (Darker/Lighter)
Print Reproduction Ratio		Zoom (50% to 200%), Free, 100% reproduction ratio, Margin+ (90% to 99%), Enlargement (163%, 141%, 122%, 116%), Reduction (87%, 82%, 71%, 61%)
User Interface		Color touch panel
Functions		Image, Contrast, Size, Paper Size Detection, D-Feed Check, Dot Process, Contrast Adj, Tone Curve, Layout, Multi-Up Print, 2 Up, Book Shadow, Top Margin Adj., Binding Margin Adj., Max. Scan, Ink Saving, Quick Master Making, Preview, ADF Semi-Auto ⁵ , Storage, Overlay, Print Speed Adjustment, Print Density Adjustment, Print Position Adjustment, Interval, Renew Page, Auto Page Renewal, Rotate, Special Paper Ctrl, Output reversal, Scanning Side -ADF ⁵ , Paper Memory Print, Program, Job Separation ⁶ , Slip sheet sorting, Job Memory, Reservation, Editor, Idling Action, Confidential, My Direct Access, Meter Display, ID Counter Report, Proof Copy, Direct Printing, USB Job List, Scanning Mode, Admin., Auto Sleep, Auto Power-OFF, Power-OFF Schedule, ECO mode, Protect, RISO iQuality System
PC Interface		USB2.0, Ethernet: 100BASE-TX/10BASE-T
Ink Supply		Full automatic (1000 ml/cartridge)
Master Supply/Disposal		Full automatic A3 approx. 220 sheets per roll / Disposal capacity: approx. 100 sheets
Power Source		SF9390E: AC 220-240 V, 50-60 Hz <2.2 A>, SF9390A (For Korea: AC 220 V, 60 Hz <2.2 A>, For other countries: AC 100-240 V, 50-60 Hz <5.0-2.2 A>)
Power Consumption	Standard	Max. 430 W (AC 100-120 V), 400 W (AC 220-240 V), Ready: 40 W or lower, Sleep: (Standard) 5 W or lower, (Low) 0.5 W or lower, Power-OFF: 0.5 W or lower
	Optional Accessories Connected^{*7}	Max. 430 W (AC 100-120 V), 400 W (AC 220-240 V), Ready: 45 W or lower, Sleep: (Standard) 10 W or lower, (Low) 1.5 W or lower, Power-OFF: 0.5 W or lower
Dimensions (W×D⁸×H⁹)	In use	1420 mm × 705 mm × 1065 mm
	In storage	780 mm × 705 mm × 1065 mm
Required Space (W×D×H⁹)		1420 mm × 1310 mm × 1515 mm
Weight^{*10}		Approx. 111 kg

*1 Measurement value when set to 100% reproduction ratio. *2 When the optional Wide Stacking Tray is installed, you can use paper up to a size of 340 mm × 555 mm by setting [Custom Paper Entry]. Depending on the paper type and paper size, papers may not be aligned properly. *3 When using the following weight of paper; 64gsm to 80gsm *4 If the temperature of the inside of the print drum (cylinder) is less than 15°C, [190ppm] is not usable. If the temperature of the inside of the print drum (cylinder) is less than 5°C, [160ppm] is not usable. *5 Usable when the optional auto document feeder is installed. *6 Usable when the optional Job Separator is installed. *7 When all the following optional accessories are installed. Auto Document Feeder, Job Separator and IC Card Reader *8 The depth includes the stabilizers for the dedicated rack. *9 The height includes the dedicated rack. *10 The weight does not include the ink, master roll, and rack.

Notes: Specifications are subject to change without notice.

RISO iQualitySystem™



The RISO iQuality mark indicates a RISO product compatible with the RISO iQuality System.



RISO INK F TYPE Color (1000 ml)



RISO MASTER F TYPE HG97
RISO MASTER F TYPE HD87
(A3: 220 sheets)



RISO INK F TYPE HD BLACK
(1000 ml)

RISO, RISO iQualitySystem and are trademarks or registered trademarks of RISO KAGAKU CORPORATION in the United States and other countries. Other corporate names and/or trademarks are either registered trademarks or trademarks of each company, respectively. Copyright ©2017 RISO KAGAKU CORPORATION. All rights reserved.



RISO KAGAKU CORPORATION
5-34-7 Shiba, Minato-ku, Tokyo 108-8385 Japan
<http://www.riso.com/>

For more details please contact: